

DEBIX SOM A I/O Board

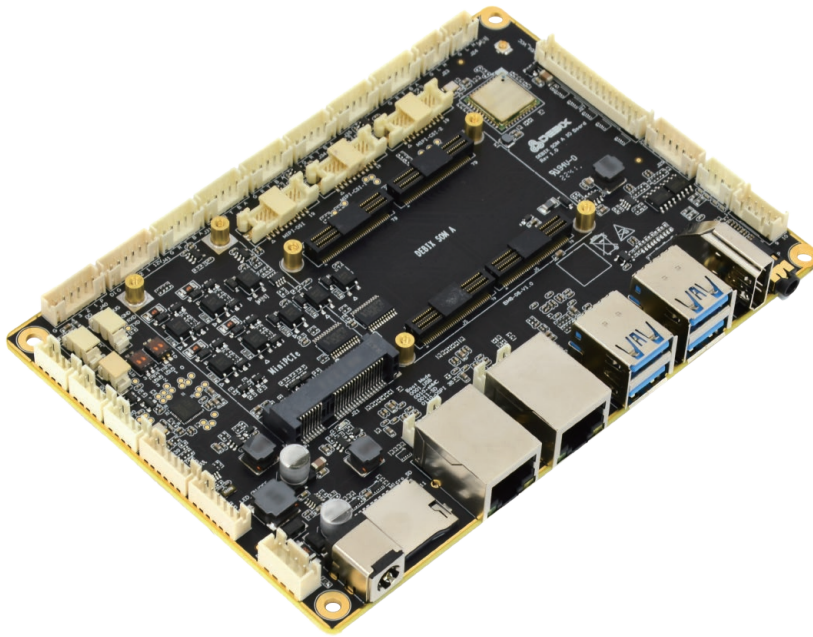

DEBIX SOM A I/O Board

Overview:

DEBIX SOM A I/O Board is a carrier board designed for DEBIX SOM A, which connects to DEBIX SOM A through 4 double-sided board-to-board socket connectors on its front side. It's all about full-featured interfaces supported by the core board based on i.MX 8M Plus, and provides a perfect solution combining the functions required for industrial control, IoT connection and multimedia.

Main Features:

- **Feature-rich interfaces** to take advantage of the i.MX 8M Plus processor to the fullest extent
- **Flexible boot options:** Besides boot from eMMC on DEBIX SOM A, the I/O Board supports boot from Micro SD and SPI Nor Flash
- **Industrial-grade isolation:** The serial ports, CAN and GPIO of the I/O Board are designed with isolation, dedicated to industrial and IoT applications
- **Powerful Connectivity:** Support dual Gigabit Ethernet with POE function, 2.4GHz & 5GHz Wi-Fi and Bluetooth 5.0

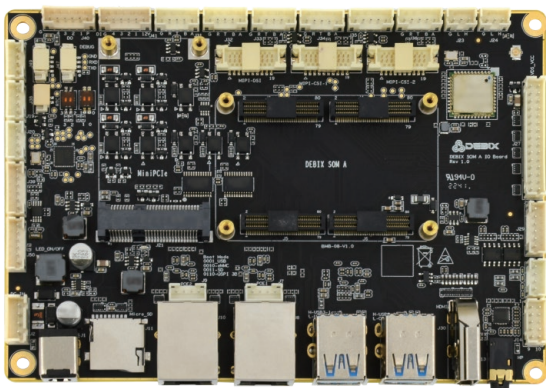

(Front View)

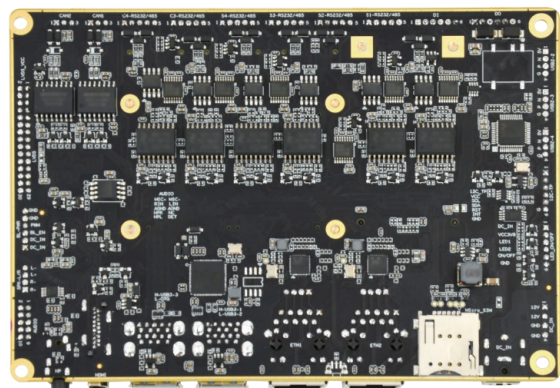

(Back View)

Specification:

System	
Core Board	DEBIX SOM A
Boot	(1) Support boot from eMMC on DEBIX SOM A (2) Support boot from Micro SD on carrier board (3) Support boot from SPI Nor Flash on carrier board (reserved)
Vedio & Audio	
HDMI	1 x HDMI output, Type-A female socket
LVDS	(1) 1 x Dual-channel LVDS output, support single-channel 8bit and dual-channel 8bit output (2*15Pin/2.0mm pin header) (2) 1 x Backlight control connector (1*6Pin/2.0mm pin header) (3) 1 x I2C touch panel connector (1*6Pin/2.0mm pin header)
MIPI DSI	1 x 4Lane MIPI DSI (2*10Pin/1.25mm pin header)
MIPI CSI	2 x 4Lane MIPI CSI (2*10Pin/1.25mm pin header)
Audio	(1) 1 x Headphone and mic combo port, 3.5mm socket, compatible with built-in header design (2) 1 x Line in, analog input (3) 1 x L&R speaker output, Max. 3W@4Ω (1*4Pin/2.0mm pin header) (4) 1 x SPDIF TX/RX audio connector (1*4Pin/1.25mm pin header)
Communication	
Ethernet	2 x Independent MAC Gigabit RJ45 port with POE power supply (need POE power device module)
WIFI & BT	2.4GHz & 5GHz Wi-Fi and Bluetooth 5.0, external SMA antenna connectors for Wi-Fi and 4G
Other I/O Interfaces	
SIM Slot	1 x Micro SIM slot, push pop-up slot
SD Slot	1 x Micro SD slot, push pop-up slot
Mini PCIe	(1) Support 4G Mini PCIe module such as Quectel 4G Module, built-in SIM card, etc. (2) Support LoRa Mini PCIe module (3) Support Mini PCIe expansion for network card, SATA and serial port
USB 3.0	4 x USB 3.0 Host, double-layer Type-A interface
USB 2.0	3 x USB 2.0 Host (1*4Pin/2.0mm pin header)
Serial Ports	(1) 6 x Isolated RS232/RS485 (you can choose only one of two), compatible with UART TTL 3.3V without isolation (2) 1 x UART TTL 3.3V system debug port
GPIO	(1) 4 x Isolated DI, support dry contact and wet contact (2) 4 x Isolated DO, support wet contact, compatible with dry contact of external relay
CAN	2 x Isolated CAN
LED & Key	(1) 1 x Power LED (2) 2 x Programmable LED (3) 1 x ON/OFF The above interfaces share one connector (1*6Pin/2.0mm pin header) (4) Built-in small key for eMMC upgrade without disassembly
DC Jack	(1) 1 x DC jack for 5.5mm x 2.1mm DC plug (2) 1 x Built-in power supply connector (1*4Pin/2.54mm pin header)
Power Supply	
Power Input	DC 12V/2A for default, support wide voltage range of DC 12V~36V
Mechanical	
Size	146.0mm x 102.0mm
Operating Temp.	-20℃~70℃ for default, -40℃~85℃ optional

I/O Interfaces:

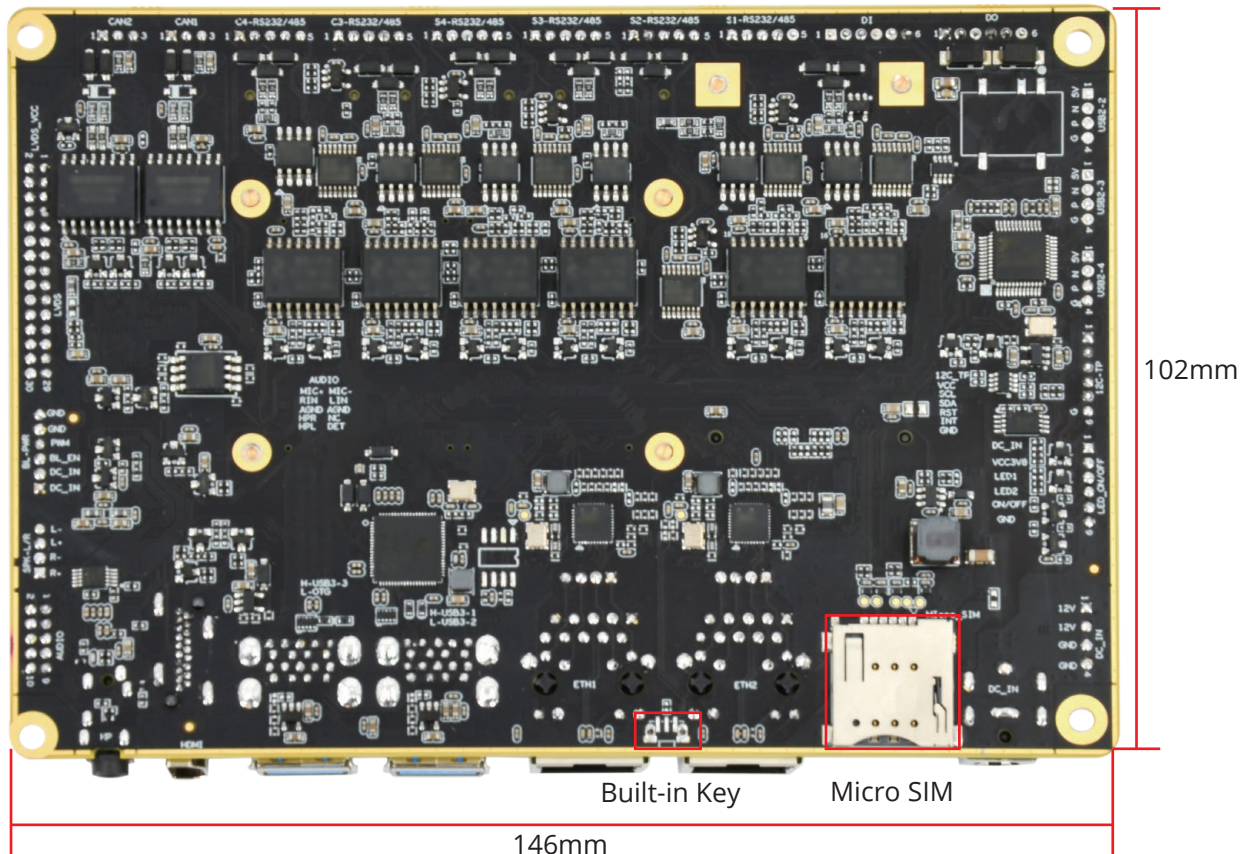
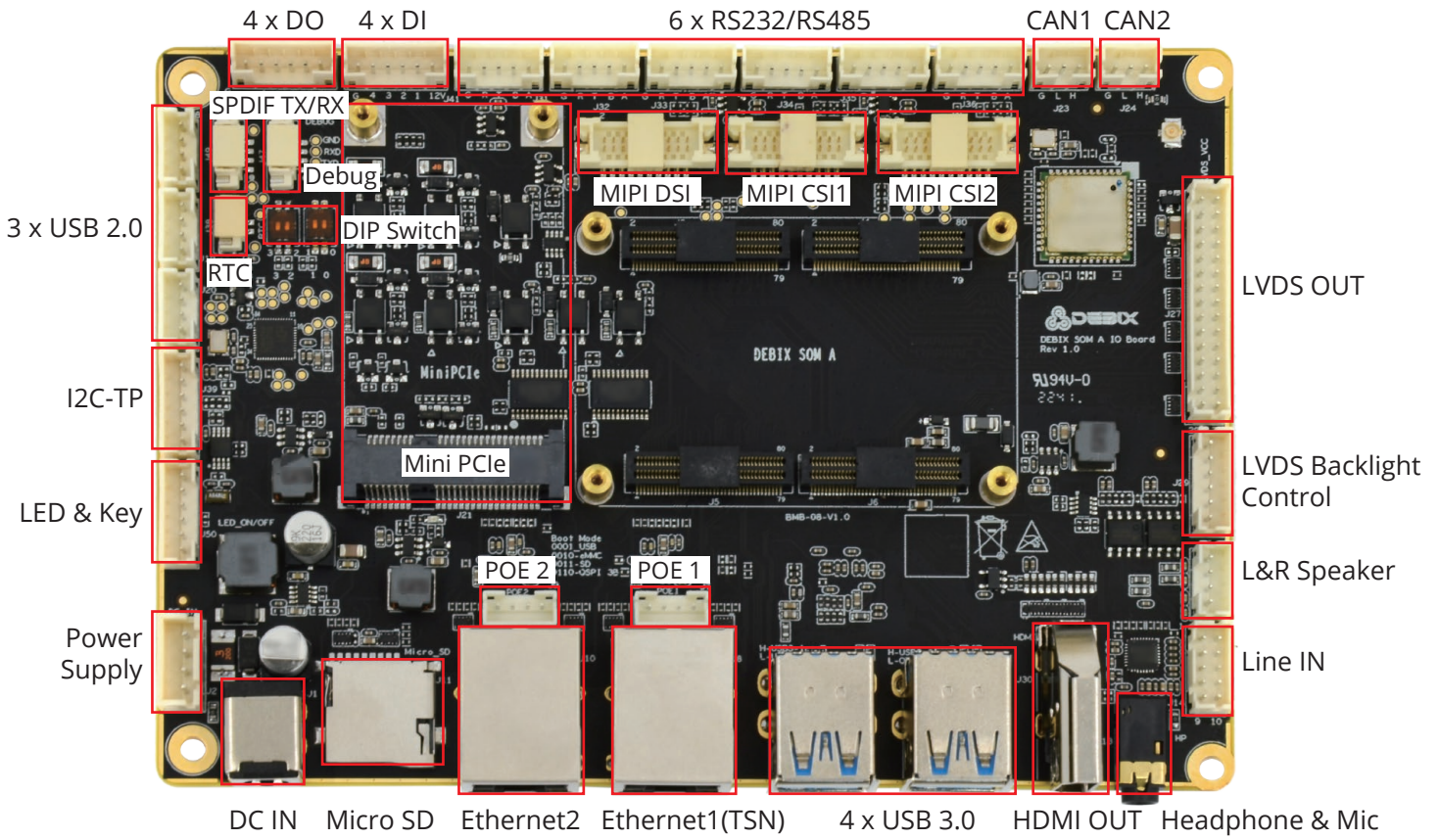

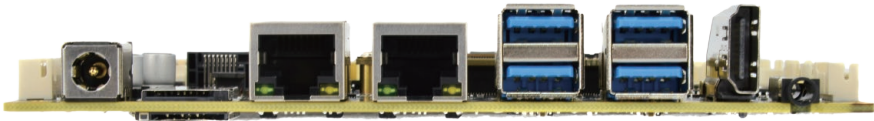

Connection with DEBIX SOM A:

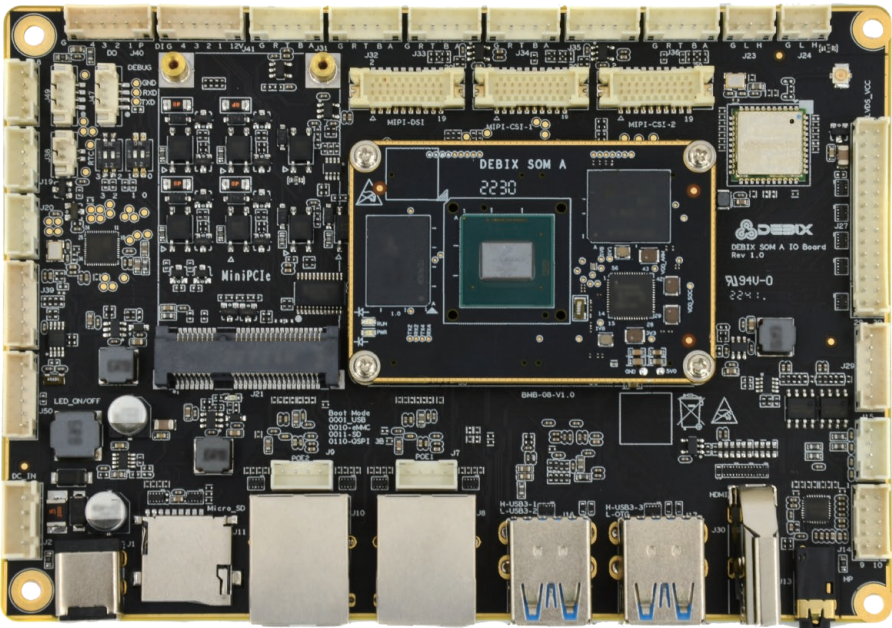

Safety Instruction and Warnings:

General:

- Avoid exposure to water, moisture, and conductive surfaces while operating.
- Handle with care to avoid mechanical or electrical damage to the circuit board and connectors.
- Only handle the board by the edges when powered on to minimize the risk of electrostatic discharge damage.

Power:

- Only use the product with a DEBIX SOM A and a 12V/2A DC external power supply that complies with relevant regulations and standards for your country.

Environment:

- Operate in a well-ventilated environment, even if using a case.
- Place on a stable, flat, non-conductive surface and avoid contact with conductive items.

Connections:

- Only connect compatible devices to the GPIO ports to avoid damage and warranty voiding.
- Use peripherals that comply with relevant standards for the country of use and ensure proper insulation and operation.

Additional notes:

- This summary is not exhaustive, please refer to the full User Manual for details.
- If you are unsure about any aspect of safety or operation, consult a qualified professional.

Contact Us:

Headquarters: DEBIX Technology Inc., 8345 Gold River Ct., Las Vegas, NV 89113, USA

Factory: 5-6/F., East Zone, Shunheda A2 Building, Liuxiangdong Industrial Park, Xili, Nanshan Dist., Shenzhen, China

Email: info@debix.io

Website: www.debix.io

Community: <https://discord.com/invite/adaHHaDkH2>

